



Microbiological **Safety Cabinets**
and **Laminar Air Flow Solutions**
engineered by **experience**.

n-Safe Product range

n-Safe Pro

n-Safe Pro One

n-Safe Cyto

n-Safe XL

n-Safe B2

n-Safe Sterile

n-Safe Horizontal

n-Safe Class I

n-Safe Class III

n-Safe Isotope



Special is
our standard.

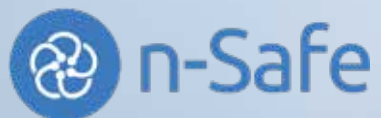

Table of contents



4-5	Engineered by experience	18-19	n-Safe B2
6-7	Special is our standard	20-21	n-Safe Sterile
8-9	Options without limit	22-23	n-Safe Horizontal
10-11	n-Safe Pro Class II Cabinets according to EN 12469 and NSF / ANSI 49	24-25	n-Safe Class I
12-13	n-Safe Pro One Class II Cabinets according to EN 12469 and NSF / ANSI 49	26-27	n-Safe Class III
14-15	n-Safe Cyto Class II 3-Filter Cabinets according to EN 12469 and DIN 12980	28-29	n-Safe Isotope
16-17	n-Safe XL		





Engineered by experience

Compact design, which doesn't compromise the best usable inner dimensions.

Nordic Labtech manufactures intelligent engineered, biological safety cabinets, which provide clean air solutions for a wide range of applications, ranging from routine work with potentially hazardous samples to the handling of cytotoxic compounds. n-Safe products provide the level of operator, product and environmental protection you need, while every cabinet is designed to make your daily work as safe, easy and comfortable as possible.

Biological safety

n-Safe cabinets have been tested and validated at our Customers' laboratories since 2015, proving their outstanding performance, high levels of reliability and quality as well as ease of use. Using the latest technology in combination with State-of-the art technique the n-Safe range offers advanced products, which are easy to clean and to maintain. Scandinavian design brings ergonomics to a higher level: dimmable LED light is a standard feature and comes together with remarkably low sound levels. Support stands are available in an either manually or electrically adjustable version – both in clean room design.



Worldwide remote support

n-Safe microbiological safety cabinets can also be ordered with an unique remote support – offering unmatched user support, trouble shooting, software adjustments and other update services. Furthermore the system allows up to 12 months of continuous data backup.

With our customer's approval we can access the cabinet remotely wherever it is installed, which only requires an open internet access. High security and without managing firewalls.



Compact design

n-Safe cabinets are by far the most compact devices, available in the market, while offering best usable tabletop space and inner dimensions. With its low depth and height, it is easy to transport n-Safe cabinets into your laboratory. The low height also allows you to use elevated support stands with a working height of up to 1100 mm and without limiting the possibility of ducting or jeopardizing safety due to coming too close to the ceiling.



Noise

Field tests proved, that the noise level of n-Safe cabinets was measured <46 dB(A) when operating according to EN12469 at 0,45 m/s inflow and 0,28 m/s down flow. By applying the latest filter and fan technology into our products, we achieve best results. State of the art filter technology – superior low noise!



User friendliness

The n-Safe R&D team members have had the users in mind when they designed the cabinets, its display interface and overall intuitivity. Ease of use and the best ergonomics possible have been their development targets.

“We offer superior flexibility, functionality and ergonomics to our customers”.

n-Safe cabinets always come with low noise levels, comfortable dimmable LED light and a wide range of options and accessories.



Standard features

All n-Safe biological safety cabinets come with dimmable LED light. Adjustable or electrical elevated support stands at your choice can be operated directly from the cabinet's touch panel.

UV-light is positioned with easy access and available in either fluorescent standard tube or with UVC-LEDs for an incomparable long life. User friendly segmented 300 mm wide tabletops allow easy cleaning.



Clean room design

We work closely with our customers to develop and to produce biological safety cabinets, which offer unmatched quality, accuracy and reliability with the highest level of cleanability.

Superior Operator Protection



Special is our standard

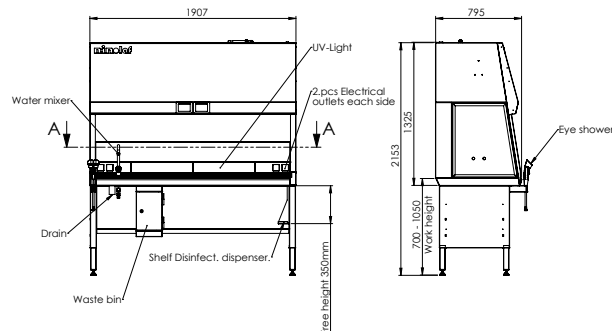

Customisation

"Special is our standard" is the Nordic Labtech motto and philosophy, meaning that all n-Safe products can be custom-made and configured to meet every specific requirement within reasonable time and budget.



Polypropylene Body

The Microbiological Safety Cabinet n-Safe PP is a metal free version with a body made from polypropylene. No metal parts in the work chamber or in the air system.

Fans without any exposed metal parts and filters with wooden frames. Manufactured according to EN 12469.



Weighing

n-Safe offers a wide range of weighing accessories – since the n-Safe cabinets are close to be vibration free, weighing at 4 decimals is possible without and up to 6 decimals with the n-Safe support option.



Split filter technology

Cabinets can be supplied with split filter technology according to your needs.



VHP decontamination

We offer a wide range of solutions for VHP fumigation. Standard or customized according to your needs. We adapt to most manufacturers of VHP systems.



Cleanability

The front windows of all n-Safe cabinets are supported by gas dampers and can therefore be easily and completely folded up for cleaning. The segmented table tops are designed for easy and convenient handling in order to further support cleanability.

A wide range of options

- Electrically elevated support stand for optimized ergonomics
- Castors
- Prefilter grid
- G3 prefilter
- Hard duct connector with or without antiblowback valve
- Thimble connector
- Double exhaust HEPA filter
- Activated carbon exhaust filter
- Outlets for electricity, LAN, USB, etc
- UV-light
- Gas taps
- Front window that can be lowered for safe inside cleaning from above IV bar
- Stainless steel tube for particle counter
- Monitor in the back wall
- Stainless steel elevated armrests
- Cooling top for water cooling of exhaust air
- VHP fumigation kit
- Table top segments in different sizes
- AISI 316 table tops
- Table tops made from solid laminate
- Single piece table top with gas dampers
- Stainless steel interior AISI 304 or AISI 316
- Extra pressure sensor for duct or plenum
- Magnetic black screen for visualization of samples



Options without limit

Whatever options you might need – we have it or it will be designed to meet your requests. We offer a wide range of options:

- UV light, integrated or standalone magnetic version allowing crossbeam functionality.
- Support stands in three different versions: basic fixed, adjustable or electrically elevated.
- The electrically elevated support stand is available in standard or heavy duty version for high loads.
- Gas valves for all types of gasses in all different qualities.



Operator in mind when designing - easy cleaning



Validation



We offer complete validation packages (DQ/IQ/OQ) for standard n-Safe products as well as for customized solutions – either with our standard documentation or customized according to your individual specifications.

Whenever you require a customized solution, we recommend a Factory Acceptance Test and Site Acceptance Test.



Table top solutions

Single piece table top solutions with and without gas dampers. The perforations in the n-Safe cabinets are engineered to an optimum, in order to provide a silent and safe air flow and also the best usable inner dimensions with 15% more usable table top area compared to most other brands.

The n-Safe product range is designed to be comfortable and ergonomically without arm rests thanks to intelligent designed, v-shaped tabletops, which allow the users to work comfortably without the risk, to obstruct the air vents.

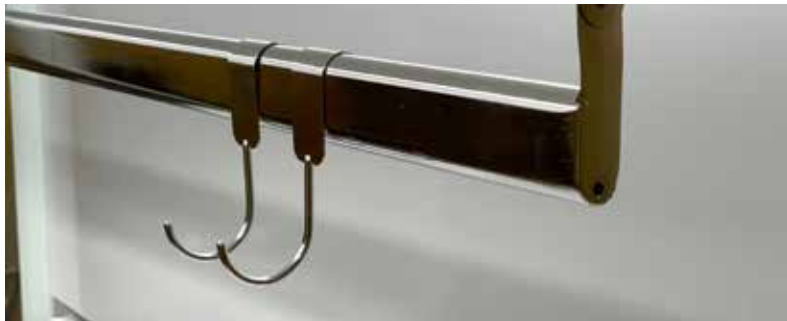

IV-Bars

IV Bars are available for all n-Safe cabinets and sizes. For maximal flexibility the height of the bars is adjustable and hooks come in two different lengths for usability.

The design of the bar is oval in order to assure, that the hooks will stay in place.

Ducting options

n-Safe cabinets can be delivered with several ducting options: thimble or hard duct – with and without anti blow back valve.

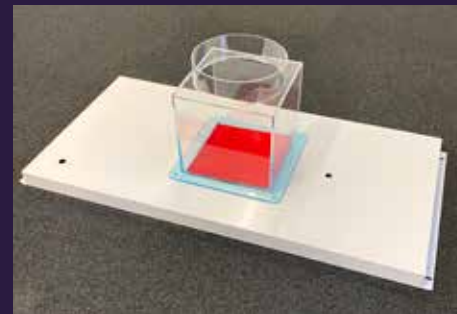



n-Safe Pro - Class II Cabinets according to EN 12469 - provide:

- Product protection
- Operator protection
- Environmental protection

n-Safe Pro

Superior Operator and Product Protection



The n-Safe Pro cabinets are our bestsellers, when it comes to Microbiological (Class II) Safety Cabinets, which are designed, to provide superior operator and product protection according to EN-12469.

All n-Safe Pro cabinets feature an intuitive controller with large double touch displays and are equipped with a MODBUS interface for reading and controlling. The remote service feature, which allows technical support via ethernet, over distance and wherever in the world your cabinet was installed, is available as an option. The n-Safe Pro cabinets can be delivered with a long list of options and can be customized to fulfil any requirement.

Electrically elevated support stands can be controlled via the cabinet's touch screen as well, which means that everything is operated from one spot. Excellent energy saving, dimmable LEDs provide up to 2.000 Lux of uniform and shadow free light, which is distributed over the whole working area. The back walls of the n-Safe Pro cabinets are powder coated in white colour for best lumination and to reduce reflections. The latest fan and filter technology in combination with excellent engineering and design provides outstanding low noise levels for all cabinet sizes.

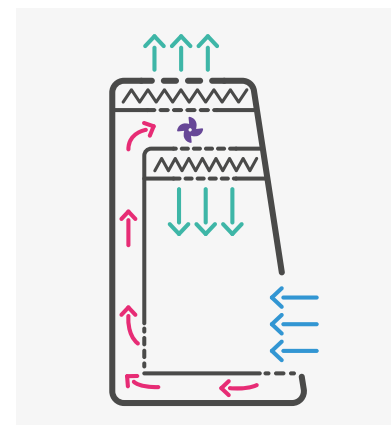
Airflow schematics



-  Contaminated air
-  Filtered air
-  Ambient air

Technical specifications

Size		900	1200	1500	1800
Dimensions					
External dimensions excl support, WxDxH	mm	1003x799x1329	1303x799x1329	1603x799x1329	1907x799x1329
External dimensions incl support, table top at 800 mm, WxDxH	mm	1003x799x2053	1303x799x2053	1603x799x2053	1907x799x2053
Internal dimensions, WxDxH	mm	900x520(625)x700	1200x520(625)x700	1500x520(625)x700	1800x520(625)x700
Front window opening	mm	200 (adjustable 160 - 330)			
Work height, basic support stand	mm	800 or 900 (±25)			
Work height, adjustable support stand	mm	700-1050			
Work height, electrically elevated support stand	mm	750-1050			
Minimum door way	mm	800			
Weight		900	1200	1500	1800
Equipment	kg	190	220	250	280
Air Velocity					
Vertical Flow	m/s	0,28 (adjustable 0,25 - 0,53)			
Inflow	m/s	0.45 (adjustable 0.45 - 0.55)			
Deviation	+-%	<8			
Noise		900	1200	1500	1800
Noise level, measured according to EN12469 measured under optimal conditions and settings	db(A)	46	47	48	49
Ventilation					
Down flow rate	m3/h	510	680	840	1010
Exhaust flow rate	m3/h	290	390	480	580
Filter Technology					
Main/Exhaust	type	HEPA H14 EN1822, 99,999% at 0,3 µm particle size			
Light					
LED	lux	0-2000, dimmable			
Electrical data					
Voltage frequency	V/Hz	220-240/50-60 or 110-120/50-60			
Power consumption, from	W	90	100	130	140

Our models are built and tested according to national and international standards, including EN 12469, NSF/ANSI 49, EN61010-1

Dimensions

Cabinet	A - Length	B - Work height	C - Top cabinet	D - Highest point	E - Work opening	W -Weight
n-Safe 900	1003 mm	700-1050 mm	1953-2303 mm	1978-2328 mm	900 mm	190 kilo
n-Safe 1200	1303 mm	700-1050 mm	1953-2303 mm	1978-2328 mm	1200 mm	220 kilo
n-Safe 1500	1603 mm	700-1050 mm	1953-2303 mm	1978-2328 mm	1500 mm	250 kilo
n-Safe 1800	1907 mm	700-1050 mm	1953-2303 mm	1978-2328 mm	1800 mm	280 kilo

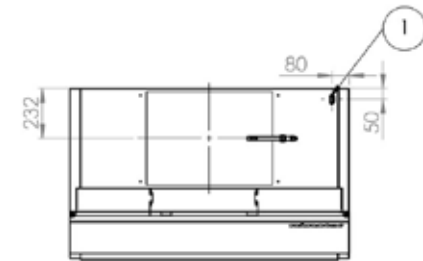
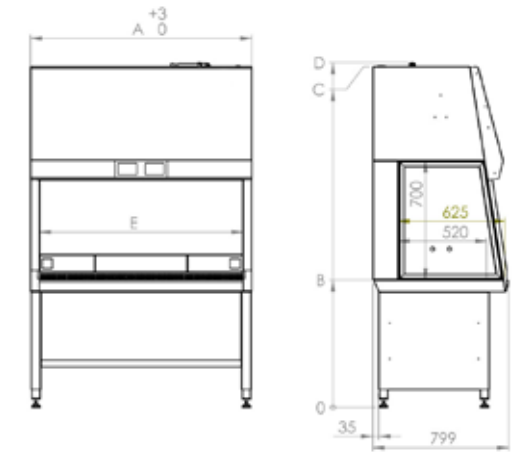

Notes

POS.	Description
1	Power Supply Unit



n-Safe Pro One - Class II Cabinets according to EN 12469 - provide:

- Product protection
- Operator protection
- Environmental protection

n-Safe Pro One

Best Value

The n-Safe Pro One is probably the most affordable safety cabinet on the market – better value for money is difficult to find! Fulfilling most laboratories' requirements it comes with a touch display for intuitive operation and easy-to-clean, segmented tabletops.

It goes without saying, that n-Safe Pro One cabinets are fully compliant with EN 12469 and feature the same high level of quality and ergonomics as the rest of the n-Safe products. Most standard options are available for n-Safe Pro One cabinets as well, while this product range doesn't allow customization. Can be ordered with painted sides or with side windows.

Airflow schematics

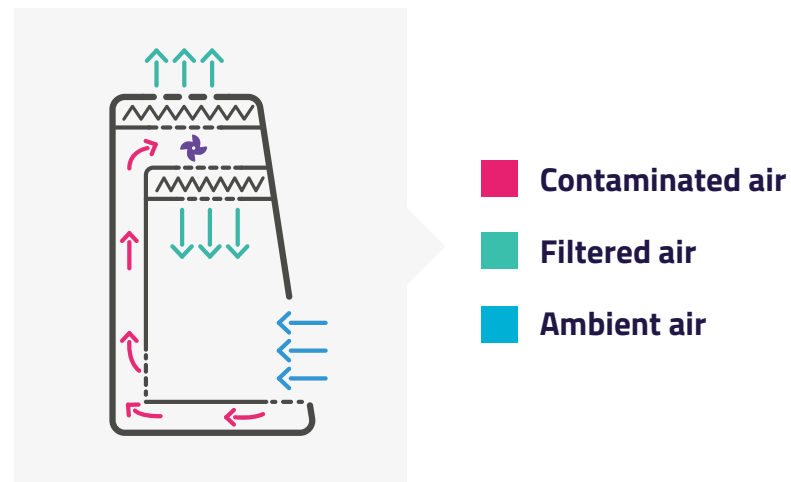

Technical specifications

Size		600	900	1200	1500	1800
Dimensions						
External dimensions excl support, WxDxH	mm	600x778x1375	1003x799x1329	1303x799x1329	1603x799x1329	1907x799x1329
External dimensions incl support, table top at 800 mm, WxDxH	mm	600x778x2078	1003x799x2053	1303x799x2053	1603x799x2053	1907x799x2053
Internal dimensions, WxDxH	mm	540(597)x530(640)x700	900x520(625)x700	1200x520(625)x700	1500x520(625)x700	1800x520(625)x700
Front window opening	mm	200 (adjustable 160 - 330)				
Work height, basic support stand	mm	800 or 900 (±25)				
Work height, adjustable support stand	mm	700-1050				
Work height, electrically elevated support stand	mm	750-1050				
Minimum door way	mm	730	800	800	800	800
Weight						
Equipment	kg	145	190	220	250	280
Air Velocity						
Vertical Flow	m/s	0,28 (adjustable 0,25 - 0,53)				
Inflow	m/s	0.45 (adjustable 0.45 - 0.55)				
Deviation	+-%	<8				
Noise						
Noise level, measured according to EN12469 measured under optimal conditions and settings	db(A)	45	46	47	48	49
Ventilation						
Down flow rate	m3/h	510	510	680	840	1010
Exhaust flow rate	m3/h	180	290	390	480	580
Filter Technology						
Main/Exhaust	type	HEPA H14 EN1822, 99,999% at 0,3 µm particle size				
Light						
LED	lux	0-2000, dimmable				
Electrical data						
Voltage frequency	V/Hz	220-240/50-60 or 110-120/50-60				
Power consumption, from	W	60	90	100	130	140

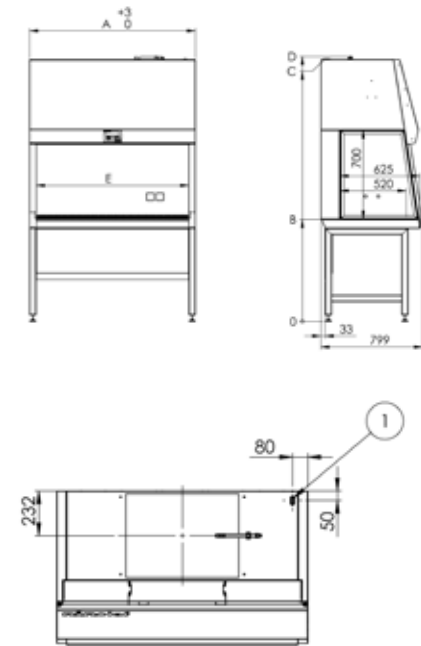

Notes

POS.	Description
1	Power Supply Unit

Our models are built and tested according to national and international standards, including EN 12469, NSF/ANSI 49, EN61010-1

Dimensions

Cabinet	A - Length	B - Work height	C - Top cabinet	D - Highest point	E - Work opening	W - Weight
n-safe 600	600 mm	800 mm ±25	2058 mm ±25	2077 mm ±25	540 (597) mm	150 kg
n-Safe 900	1003 mm	800 mm ±25	2058 mm ±25	2077 mm ±25	900 mm	175 kilo
n-Safe 1200	1303 mm	800 mm ±25	2058 mm ±25	2077 mm ±25	1200 mm	205 kilo
n-Safe 1500	1603 mm	800 mm ±25	2058 mm ±25	2077 mm ±25	1500 mm	235 kilo
n-Safe 1800	1907 mm	800 mm ±25	2058 mm ±25	2077 mm ±25	1800 mm	265 kilo



n-Safe Cyto

No Limit - Outstanding Low Noise

The n-Safe Cyto is a very sophisticated 3-filter cabinet, which is equipped with easy-to-change H14-cartridge-prefilters, which feature an exceptionally low pressure drop. This means low service costs and very low noise levels. The extremely low energy consumption of n-Safe Cyto cabinets leads to a very low CO2 footprint.

The cartridge design of the H14-prefilters is very compact and therefore the n-Safe Cyto cabinets allow a comfortable sitting position with excellent leg space. n-Safe Cyto cabinets are manufactured and tested according to EN12469 as well as DIN12980 and offer the same standard features and customization opportunities as n-Safe Pro cabinets.

While for Germany, Switzerland, The Netherlands, Austria and Denmark only square filter cartridges are available, the rest of our Customers can choose between circular cartridges and the even more compact square design.

Airflow schematics

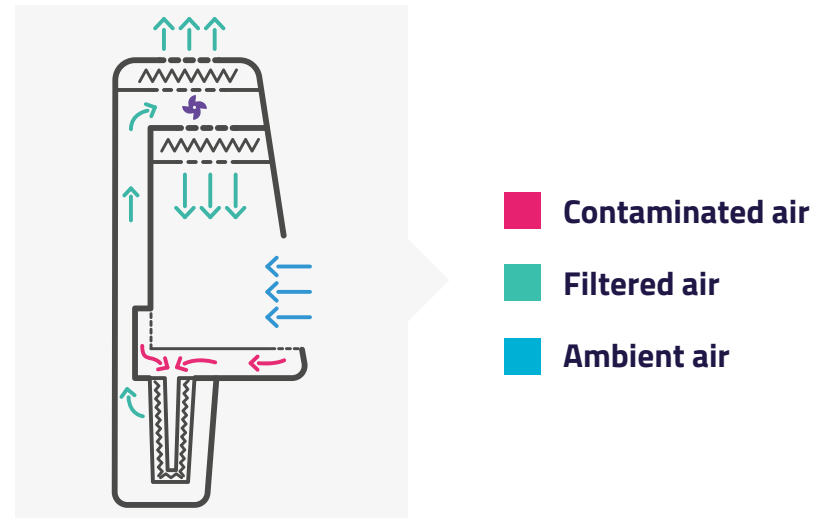

n-Safe Cyto - Class II Cabinets according to EN 12469 and DIN 12980 - provide:

- Product protection
- Operator protection
- Environmental protection
- All air double HEPA-filtered

Technical specifications

Size		900	1200	1500	1800
Dimensions					
External dimensions excl support, WxDxH	mm	1003x799x1843	1303x799x1843	1603x799x1843	1907x799x1329
External dimensions incl support, table top at 800 mm, WxDxH	mm	1003x799x2053	1303x799x2053	1603x799x2053	1907x799x2053
Internal dimensions, WxDxH	mm	900x520(625)x700	1200x520(625)x700	1500x520(625)x700	1800x520(625)x700
Front window opening	mm	200 (adjustable 160 - 330)			
Work height, adjustable support stand	mm	700-1050			
Work height, electrically elevated support stand	mm	750-1050			
Minimum door way	mm	800			
Weight		900	1200	1500	1800
Equipment	kg	210	240	270	300
Air Velocity					
Vertical Flow	m/s	0,28 (adjustable 0,25 - 0,53)			
Inflow	m/s	0,45 (adjustable 0,45 - 0,55)			
Deviation	+-%	<8			
Noise		900	1200	1500	1800
Noise level, measured according to EN12469 measured under optimal conditions and settings	db(A)	53	54	55	56
Ventilation					
Down flow rate	m ³ /h	510	680	840	1010
Exhaust flow rate	m ³ /h	290	390	480	580
Filter Technology					
Main/Exhaust	type	HEPA H14 EN1822, 99,999% at 0,3 µm particle size			
Light					
LED	lux	0-2000, dimmable			
Electrical data					
Voltage frequency	V/Hz	220-240/50-60 or 110-120/50-60			
Power consumption, from	W	90	100	130	140

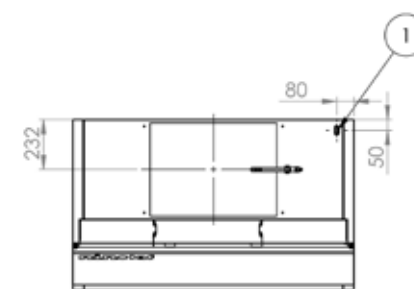
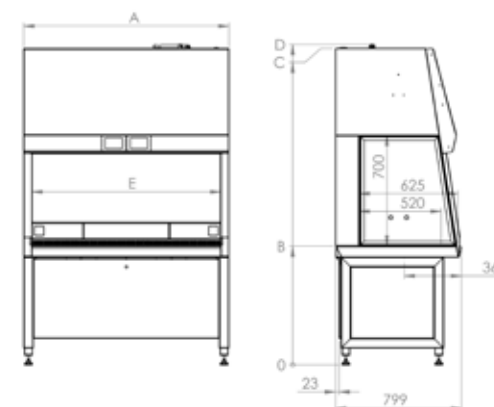

Notes

POS.	Description
1	Power Supply Unit



Circular H14 prefilters

Dimensions

Cabinet	A - Length	B - Work height	C - Top cabinet	D - Highest point	E - Work opening	W - Weight
n-Safe Cyto 900	1003 mm	700-1050 mm	1953-2303 mm	1978-2328 mm	900 mm	210 kilo
n-Safe Cyto 1200	1303 mm	700-1050 mm	1953-2303 mm	1978-2328 mm	1200 mm	240 kilo
n-Safe Cyto 1500	1603 mm	700-1050 mm	1953-2303 mm	1978-2328 mm	1500 mm	270 kilo
n-Safe Cyto 1800	1907 mm	700-1050 mm	1953-2303 mm	1978-2328 mm	1800 mm	300 kilo



n-Safe XL

Extraordinary Inner Dimensions

n-Safe XL cabinets offer extraordinary inner dimensions, whenever the working space of a standard cabinet isn't sufficient: XL cabinets come with an interior height of 1.000 mm and an interior depth of 900 mm. The complete front can be opened to easily fit in large devices, e.g. a pipetting robot.

n-Safe XL cabinets are manufactured according to EN 12469 and can also be delivered as a three-filter cabinet with H14 prefilters according to DIN12980, B2 cabinets with 100% exhaust air or as an Open Laminar Flow cabinet for product protection.

Upon request n-Safe XL cabinets would also be available with a width of up to 3.600 mm as a customized solution.

Due to outstanding inner dimensions the XL cabinets do also have large external dimensions. Therefore and due to the smart design of the n-Safe XL range, it is possible to finally assemble the devices on site in case of narrow doorways.



Optional H14 pre filters according to DIN12980



The front of the cabinets can be completely opened for an opening height of 1.000 mm

Technical specifications

Size		1200	1500	1800
Dimensions				
External dimensions excl support, WxDxH	mm	1303x1176x1652	1603x1176x1652	1907x1176x1652
External dimensions incl support, table top at 800 mm, WxDxH	mm	1303x1176x2380	1603x1176x2380	1907x1176x2380
Internal dimensions, WxDxH	mm	1200x855(970)x1000	1500x855(970)x1000	1800x855(970)x1000
Front window opening	mm	200 (adjustable 160 - 330)		
Work height, adjustable support stand	mm	700-1050		
Work height, electrically elevated support stand	mm	750-1050		
Minimum door way	mm	1180, but can be finally assembled on site		
Weight				
Equipment	kg	310	350	390
Air Velocity				
Vertical flow	m/s	0,28 (adjustable 0,25 - 0,53)		
Inflow	m/s	0.45 (adjustable 0.45 - 0.55)		
Deviation	±%	< 8		
Noise				
Noise level, measured according to EN12469 measured under optimal conditions and settings	dB(A)	56	57	57
Ventilation				
Down flow rate	m ³ /h	960	1200	1440
Exhaust flow rate	m ³ /h	390	480	580
Filter Technology				
Main/Exhaust	type	HEPA H14 EN1822, 99,999% at 0,3 µm particle size		
Light				
LED	lux	0-2000, dimmable		
Electrical data				
Voltage frequency	V/Hz	220-240/50-60 or 110-120/50-60		
Power consumption, from	W	140	180	190

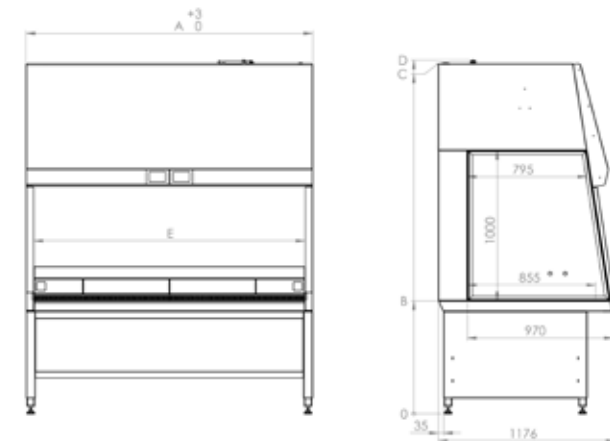

Notes

POS.	Description
1	Power Supply Unit

Dimensions

Cabinet	A - Length	B - Work height	C - Top cabinet	D - Highest point	E - Work opening	W -Weight
n-SAFE 1200 XL	1303 mm	700-1050 mm	2280-2630 mm	2300-2650 mm	1200 mm	310 kilo
n-SAFE 1500 XL	1603 mm	700-1050 mm	2280-2630 mm	2300-2650 mm	1500 mm	350 kilo
n-SAFE 1800 XL	1907 mm	700-1050 mm	2280-2630 mm	2300-2650 mm	1800 mm	390 kilo



n-Safe B2 Cabinets according to EN 12469 provide:

- Product protection
- Operator protection
- Environmental protection
- 100% exhaust

n-Safe B2



Superior Product and Operator Protection

n-Safe B2 cabinets are microbiological safety cabinets Class II B2 as described in NSF/ANSI 49. It protects the product as well as the operator and has 100% exhaust which means no recirculating air.

B2 cabinets need to be ducted, as they do not have any built in exhaust fans. n-Safe B2 cabinets provide product and operator protection according to EN 12469.

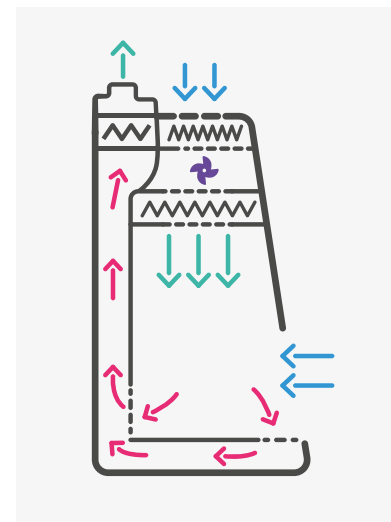
Airflow schematics



-  Contaminated air
-  Filtered air
-  Ambient air

Technical specifications

Size		1200	1500	1800
Dimensions				
External dimensions excl support, WxDxH	mm	1303x799x1405	1603x799x1405	1907x799x1405
External dimensions incl support, table top at 800 mm, WxDxH	mm	1303x799x2135	1603x799x2135	1907x799x2135
Internal dimensions, WxDxH	mm	1200x520(625)x700	1500x520(625)x700	1800x520(625)x700
Front window opening	mm	200 (adjustable 160 - 250)		
Work height, basic support stand	mm	800 or 900 (±25)		
Work height, adjustable support stand	mm	700-1050		
Work height, electrically elevated support stand	mm	750-1050		
Minimum door way	mm	800		
Weight				
Equipment	kg	235	265	295
Air Velocity				
Vertical flow	m/s	0,28 (adjustable 0,25 - 0,53)		
Inflow	m/s	0,45 (adjustable 0,45 - 0,55)		
Deviation	±%	< 8		
Noise				
Noise level, measured according to EN12469 measured under optimal conditions and settings	dB(A)	46	47	47
Ventilation				
Down flow rate	m ³ /h	680	840	1010
Exhaust flow rate (passive - needs ducting)	m ³ /h	1070	1320	1590
Filter Technology				
Main/Exhaust	type	HEPA H14 EN1822, 99,999% at 0,3 µm particle size		
Prefilter	type	G4		
Light				
LED	lux	0-2000, dimmable		
Electrical data				
Voltage frequency	V/Hz	220-240/50-60 or 110-120/50-60		
Power consumption, from	W	100	130	140

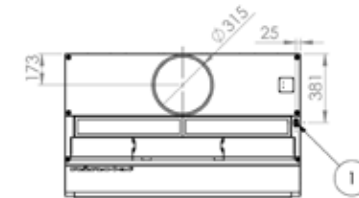
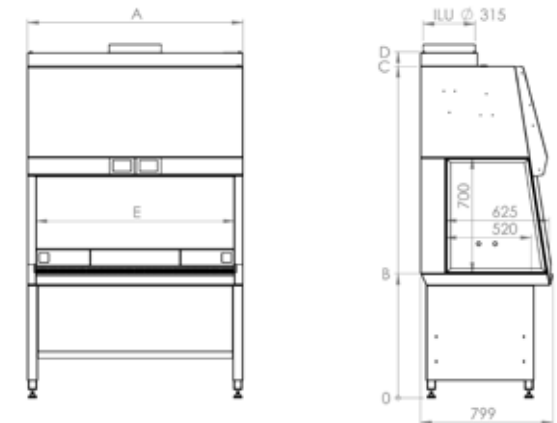

Notes

POS.	Description
1	Power Supply Unit

Dimensions

Cabinet	A - Length	B - Work height	C - Top cabinet	D - Highest point	E - Work opening	W -Weight
n-SAFE B2 1200	1303 mm	700 - 1050 mm	1953-2303 mm	2042-2392 mm	1200 mm	235 kilo
n-SAFE B2 1500	1603 mm	700 - 1050 mm	1953-2303 mm	2042-2392 mm	1500 mm	265 kilo
n-SAFE B2 1800	1907 mm	700 - 1050 mm	1953-2303 mm	2042-2392 mm	1800 mm	295 kilo



n-Safe Sterile Cabinets provide:

- Product protection

n-Safe Sterile

Best Product Production

The n-Safe Sterile is an Open Laminar Flow Cabinet, which provides a controlled environment. The products, which are handled inside the n-Safe Sterile are protected from any kind of contamination.

A certain percentage of the air inside n-Safe Sterile cabinets recirculates, which provides up to 30% longer lifetime for the HEPA-filters.

n-Safe Sterile cabinets come with easy-to-clean, one piece stainless steel table tops and offer a wide range of options as well as customization possibilities.

Airflow schematics

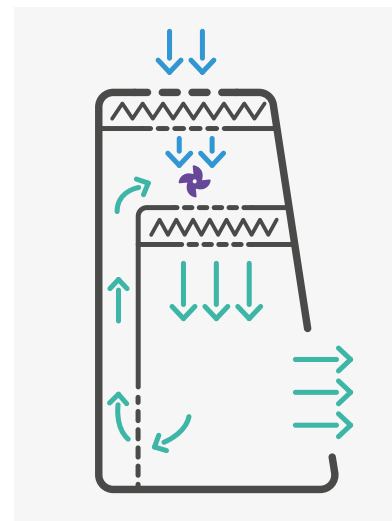

 Filtered air

 Ambient air

Technical specifications

Size		900	1200	1500	1800
Dimensions					
External dimensions excl support, WxDxH	mm	1003x799x1329	1303x799x1329	1603x799x1329	1907x799x1329
External dimensions incl support, table top at 800 mm, WxDxH	mm	1003x799x2053	1303x799x2053	1603x799x2053	1907x799x2053
Internal dimensions, WxDxH	mm	900x520(625)x700	1200x520(625)x700	1500x520(625)x700	1800x520(625)x700
Front window opening	mm	300 (adjustable 200-500)			
Work height, basic support stand	mm	800 or 900 (±25)			
Work height, adjustable support stand	mm	700-1050			
Work height, electrically elevated support stand	mm	750-1050			
Minimum door way	mm	800			
Weight					
Equipment	kg	180	220	240	270
Air Velocity					
Vertical Flow	m/s	0,28 (adjustable 0,25 - 0,53)			
Deviation	+-%	<8			
Noise					
Noise level, measured according to EN12469 measured under optimal conditions and settings	dB(A)	46	46	47	47
Ventilation					
Down flow rate	m ³ /h	510	680	840	1010
Filter Technology					
Main	type	HEPA H14 EN1822, 99,999% at 0,3 µm particle size			
Prefilter	type	G4			
Light					
LED	lux	0-2000, dimmable			
Electrical data					
Voltage frequency	V/Hz	220-240/50-60 or 110-120/50-60			
Power consumption, from	W	90	100	130	140

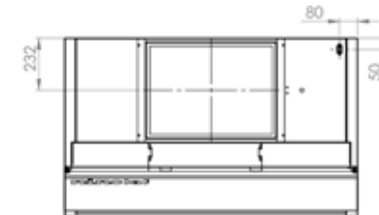
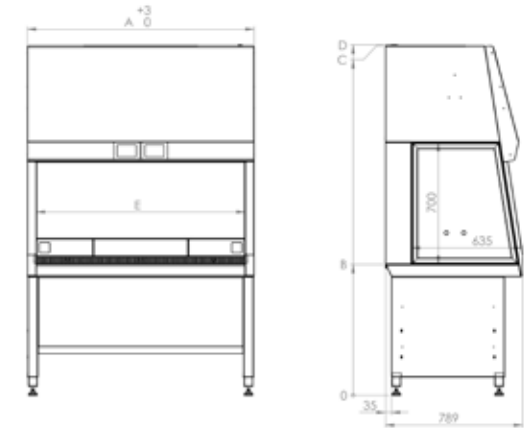

Notes

POS.	Description
1	Power Supply Unit

Dimensions

Cabinet	A - Length	B - Work height	C - Top cabinet	D - Highest point	E - Work opening	W - Weight
n-SAFE Sterile 900	1003 mm	700-1050 mm	1953-2303 mm	1958-2308 mm	900 mm	180 kilo
n-SAFE Sterile 1200	1303 mm	700-1050 mm	1953-2303 mm	1958-2308 mm	1200 mm	220 kilo
n-SAFE Sterile 1500	1603 mm	700-1050 mm	1953-2303 mm	1958-2308 mm	1500 mm	240 kilo
n-SAFE Sterile 1800	1907 mm	700-1050 mm	1953-2303 mm	1958-2308 mm	1800 mm	270 kilo



n-Safe Horizontal Cabinets provide:

- Product protection

n-Safe Horizontal

Accessible Work Area at the Best

n-Safe Horizontal devices are designed as Open Laminar Flow Cabinets, providing a controlled environment, which protects your products from being contaminated.

The cabinets feature an outstanding work height of 995 mm and come with easy-to-clean, one piece stainless steel or high pressure laminated table tops.

Airflow schematics

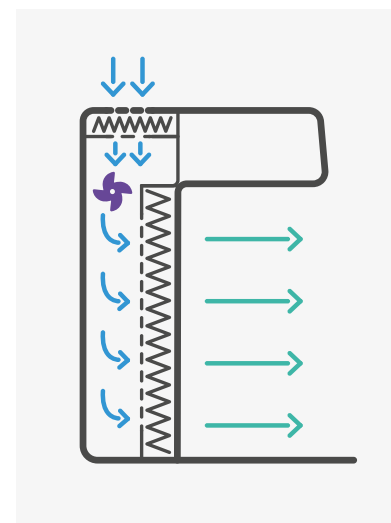

 Filtered air

 Ambient air

Technical specifications

Size		1200	1500	1800
Dimensions				
External dimensions excl support, WxDxH	mm	1303x900x1250	1603x900x1250	1907x900x1250
External dimensions incl support, table top at 800 mm, WxDxH	mm	1303x799x1955	1603x799x1955	1907x799x1955
Internal dimensions, WxDxH	mm	1200x600x995	1500x600x995	1800x600x995
Front opening	mm	995		
Work height, basic support stand	mm	800 or 900 (±25)		
Work height, adjustable support stand	mm	700-1050		
Work height, electrically elevated support stand	mm	750-1050		
Minimum door way	mm	910		
Weight				
Equipment	kg	225	255	285
Air Velocity				
Horizontal Flow	m/s	0,35 (adjustable 0,25 - 0,53)		
Deviation	+-%	<8		
Noise				
Noise level, measured according to EN12469 measured under optimal conditions and settings	dB(A)	65	67	68
Ventilation				
Down flow rate	m ³ /h	680	840	1010
Filter Technology				
Main	type	HEPA H14 EN1822, 99,999% at 0,3 µm particle size		
Prefilter	type	G4		
Light				
LED	lux	0-2000, dimmable		
Electrical data				
Voltage frequency	V/Hz	220-240/50-60 or 110-120/50-60		
Power consumption, from	W	110	140	150

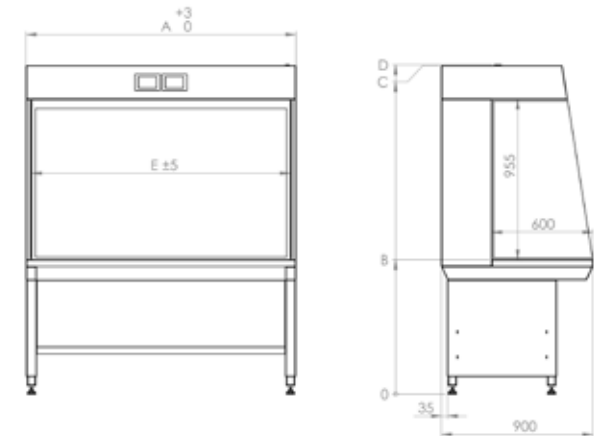

Notes

POS.	Description
1	Power Supply Unit

Dimensions

Cabinet	A - Length	B - Work height	C - Top cabinet	D - Highest point	E - Work opening	W -Weight
n-Safe Horizontal 1200	1303 mm	750 - 1100 mm	1905-2255 mm	1910-2260 mm	1238 mm	225 kilo
n-Safe Horizontal 1500	1603 mm	750 - 1100 mm	1905-2255 mm	1910-2260 mm	1538 mm	255 kilo
n-Safe Horizontal 1800	1907 mm	750 - 1100 mm	1905-2255 mm	1910-2260 mm	1842 mm	285 kilo



n-Safe Class I Cabinets according to EN 12469 provide:

- Operator protection
- Environmental protection

n-Safe Class I

First Class Operator Protection

n-Safe Class I cabinets are microbiological safety cabinets according to EN12469, which protect the operator from what is handled inside the cabinet.

It has an inflow of 0,7 m/s and an H14 exhaust filter which can be combined with an additional activated carbon filter, which is available as an option.

Airflow schematics

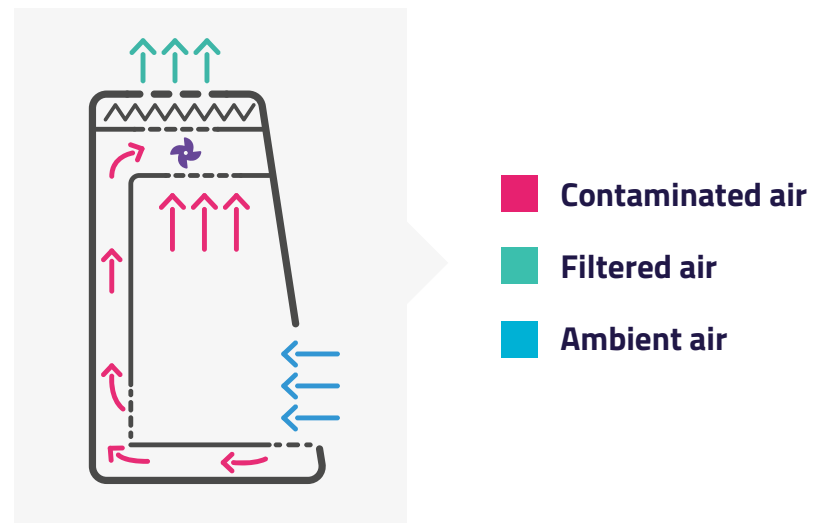

Technical specifications

Size		900	1200	1500	1800
Dimensions					
External dimensions excl support, WxDxH	mm	1003x799x1329	1303x799x1329	1603x799x1329	1907x799x1329
External dimensions incl support, table top at 800 mm, WxDxH	mm	1003x799x2053	1303x799x2053	1603x799x2053	1907x799x2053
Internal dimensions, WxDxH	mm	900x520(625)x700	1200x520(625)x700	1500x520(625)x700	1800x520(625)x700
Front window opening	mm	200 (adjustable 160 - 330)			
Work height, basic support stand	mm	800 or 900 (±25)			
Work height, adjustable support stand	mm	700-1050			
Work height, electrically elevated support stand	mm	750-1050			
Minimum door way	mm	800			
Weight					
Equipment	kg	190	220	250	280
Air Velocity					
Inflow	m/s	0,7 (adjustable 0,7 - 1,0)			
Noise					
Noise level, measured according to EN12469 measured under optimal conditions and settings	dB(A)	46	47	48	49
Ventilation					
Down flow rate	m ³ /h	460	610	760	910
Filter Technology					
Exhaust	type	HEPA H14 EN1822, 99,999% at 0,3 µm particle size			
Light					
LED	lux	0-2000, dimmable			
Electrical data					
Voltage frequency	V/Hz	220-240/50-60 or 110-120/50-60			
Power consumption, from	W	90	100	130	140

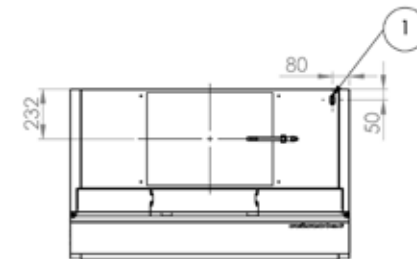
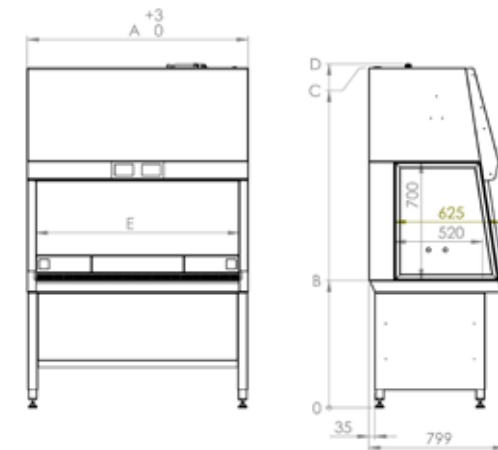

Notes

POS.	Description
1	Power Supply Unit

Dimensions

Cabinet	A - Length	B - Work height	C - Top cabinet	D - Highest point	E - Work opening	W -Weight
n-SAFE Class I 900	1003 mm	700-1050 mm	1953-2303 mm	1978-2328 mm	900 mm	190 Kilo
n-SAFE Class I 1200	1303 mm	700-1050 mm	1953-2303 mm	1978-2328 mm	1200 mm	220 kilo
n-SAFE Class I 1500	1603 mm	700-1050 mm	1953-2303 mm	1978-2328 mm	1500 mm	250 kilo
n-SAFE Class I 1800	1907 mm	700-1050 mm	1953-2303 mm	1978-2328 mm	1804 mm	280 kilo

n-Safe Class III

Superior Operator Protection – Glove box

A highly reliable Class III cabinet, designed and manufactured according to EN 12469.

n-Safe Class III cabinets are delivered with stainless steel chambers and large glove holes for best ergonomics. Supply as well as exhaust air is HEPA H14-filtered and double HEPA-14 filtration for the exhaust air is available as an option.

n-Safe Class III cabinets can also be equipped with gas tight valves for supply and exhaust and the cabinets allow easy access to all technical parts from the front.

Transfer hatches, which are available as an option on both sides, enable the users to transfer their samples or products in a secure way and it is also possible, to combine the n-Safe Class III cabinets with a Class II device.

Upon request the n-Safe Class III range is also available in other dimensions and other customized solutions.

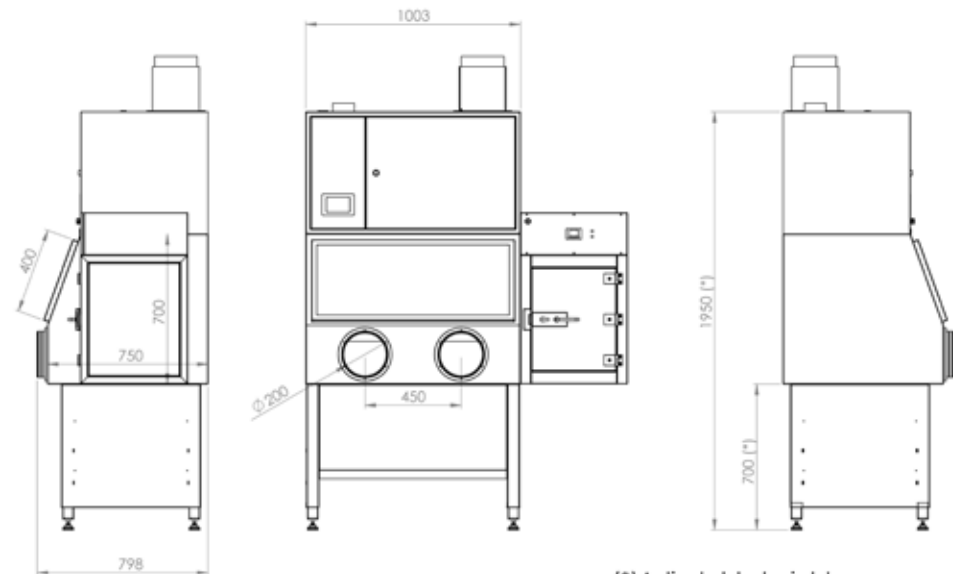

(*)Adjustable height

Technical specifications

Size	1000	
Dimensions		
External dimensions excl support, WxDxH	mm	1003x798x1290
External dimensions incl support, table top at 800 mm, WxDxH	mm	1003x799x2050
Internal dimensions, WxDxH	mm	1000x750x700
Front window door	mm	950x400
Work height, basic support stand	mm	800 or 900 (±25)
Work height, adjustable support stand	mm	700-1050
Work height, electrically elevated support stand	mm	750-1050
Minimum door way	mm	800
Weight		
Equipment	kg	210
Air velocity		
Inflow (without gloves)	m/s	> 0,7
Noise		
Noise level, measured according to EN12469 measured under optimal conditions and settings	dB(A)	<49
Ventilation		
Exhaust flow rate	m ³ /h	460
Filter technology		
Supply/Exhaust	type	HEPA H14 EN1822, 99,999% at 0,3 µm particle size
Light		
LED	Lux	0-2000, dimmable
Electrical data		
Voltage frequency	V/Hz	220-240/50-60 or 110-120/50-60
Power consumption, from	W	90

*Engineered by
experience*

n-Safe Isotope according to EN 12469 is a Microbiological Safety Cabinet for the handling of radioactive materials

n-Safe Isotope cabinets are available with a lead shielding of 1-50 mm Pb, depending on the customer's requirements. The cabinets' bottom, sides and back wall can be covered with 1-50 mm lead plates, which are encapsulated in stainless steel. n-Safe Isotope cabinets also feature a slidable front on ball bearings made of 1-50 mm Pb-equivalent lead glass.

For more than 30 mm Pb-equivalent the front can be split in two for best possible ergonomics. As options we offer integrated single or double waste chambers and dose calibrators, which can be integrated in the table top – both options are 1-50 mm Pb lead shielded and the dose calibrators can be combined with a 19" computer monitor in the back wall. Furthermore we offer generator storage with 50 mm Pb all around, for two Tc-99 generators with an integrated elevator, which can be fitted at the left or right side of the table top and which can be used for the most common generators in the market.

n-Safe Isotope cabinets are available in 1200, 1500 and 1800 sizes and are configured according to each customer's specific needs.



Generator Storage

State of the art generator storage for two Tc-99 generators. Fits all common generator brands.

Generators can easily be exchanged without lifting high. Capacity for two generators.



Radiation Shield - Standard Version

Slidable radiation shield with 1-50 mm Pb equivalent lead glass.

n-Safe Isotope Example

Radiation shielded Microbiological Safety Cabinet combined for both PET and Tc-99 with 50 mm Pb around the cabinet and 30+20 mm Pb equivalent slidable lead glass in front. Integrated generator storage, waste and dose calibrator – all with 50 mm Pb.



Radiation Shield – Split Version

Radiation shielded slidable fronts for best possible ergonomics. Split in 30 plus 20 mm Pb-equivalent lead glass which can be used separately or together for 50 mm Pb-equivalent.



Waste Compartment

50 mm Pb-shielded waste compartment with door for easy emptying to the left and 50 mm lead shielding for dose calibrator to the right.





About Nordic Labtech.

Our business concept is to offer high-tech products and solutions within advanced protective ventilation, LAF equipment and incubators, heating and climate cabinets to customers in research, hospitals and pharmaceutical as well as other industries.

We provide technical and financial added value, that helps our customers to optimize processes and applications. Our products are sold by distributors in most European countries and the rest of the world.

Our History

2013

Nino Labinterior (NLI) is founded

2014

Developed and launched customized laminar airflow solutions for pharmaceutical and animal research facilities

2015

Developed and launched n-Safe Isotope for nuclear medicine applications

2016

Developed and launched n-Safe biological safety cabinets on the Scandinavian market Public Health, UK certifies n-Safe Class II safety cabinet

2017

Developed together with Karolinska Institute and launched n-Safe mobile cage changing units on the Scandinavian market ISO9001 and ISO14001 certified

2018

NLI introduces the widest range of safety cabinets on the European Market, Achema Frankfurt NLI is appointed the largest project for safety cabinets in Scandinavia, Veterinary Institute in Oslo being the largest University building in Norway.

2019

NLI acquires Termaks A/S, a leading manufacturer of ovens and incubators in Scandinavia, by asset acquisition TÜV Nord certified manufacturer of biological safety cabinets

2020

NLI market leader in Scandinavia for standard safety cabinets, customized laminar airflow solutions and controlled environment, ovens and incubators Partners in Europe (Germany, Benelux, Switzerland among others) establishes a strong position for NLI products on the European market.

2021

NLI is appointed the largest project for safety cabinets in Europe by MEET/RIVM in Utrecht, Netherlands. New long term majority owner Screen Capital, committed to invest for our future expansion.

2022

NLI is appointed several large contracts/projects in Norway making us the absolute market leader also in Norway. The company is rebranded from Nino Labinterior to Nordic Labtech (NLT).

2023

NLT will take our new production facility in use – the largest and most modern facility in Europe, for manufacturing of MSC/LAFs and incubators.

Special is our standard.



Contacts.

 www.nordiclabtech.com

 info@nordiclabtech.com

 +46 (0) 300 358 50

 Magasinsgatan 6,
434 37 Kungsbacka, Sweden

